

Y-150 – Lot Glass for High Silica Applications

Fiberglass yarns for High Silica Fabrics come with the additional assurance that the glass ingredients are precision controlled. The lots, pallets, and doffs are chronologically numbered and maintained in sequence. No change in this system will be made without prior, written notification to the customer.

General Product Specifications

Product Information

Product	ECG150	ECG150
Glass Type	Lot Glass	Lot Glass
Filament Diameter - μm	9	9
Binder	620-1	620-1
Bobbin	9228	9228
Plies	1/0	4/0
Nominal Yield - yd/lb	14,905	3,620
Tex - g/1000 m	33.30	137.00
Tex Tolerance +/-	2.80	14.00
Nominal Solids - %	1.30	1.20
Solids Tolerance +/-	0.47	0.30
Nominal Twist - TPI (TPM)	4.0Z (Z160)	4.0Z (Z160)
Twist Tolerance +/- TPI (TPM)	0.60 (24)	0.60 (24)
Maximum Broken Filaments*	110	110
Minimum Tensile** - lb (N)	3.2 (14.2)	12.8 (56.9)

* Broken filaments based on average 360° count

** Average of 5 measurements per bobbin

Nominal Product Characteristics

(For reference only, not specified or controlled)

Average Bare Glass Tensile* - lb (N)	5.1 (22.7)	17.5 (77.8)
Approximate Yarn Diameter - in (mm)	0.0080 (0.203)	0.0137 (0.348)

* Average tensile per bobbin

Packaging Information

Bobbin	9228	9228
Nominal Bobbin Weight - lb (kg)	4.0 (1.81)	7.7 (3.49)
Minimum Bobbin Weight - lb (kg)	2.5 (1.13)	2.5 (1.13)
Metered Bobbin Length - yd (m)	59,100 (54,000)	27,000 (26,500)
Metered Ratio - %	80	80

Rev 12, 11.12.2020

Indicates a product that is made to order, which may impact availability. Please contact your AGY representative for more information.

Y-150 – Lot Glass for High Silica Applications

Nominal Packaging Dimensions

Bobbin	Pallet	Bobbins / Layer	Layers / Carton	Cartons / Pallet	Bobbins / Pallet	L-in (cm)	W-in (cm)	H-in (cm)
9228	Wood	12	3	4	144	45.5 (115.6)	45.5 (115.6)	38.5 (97.8)

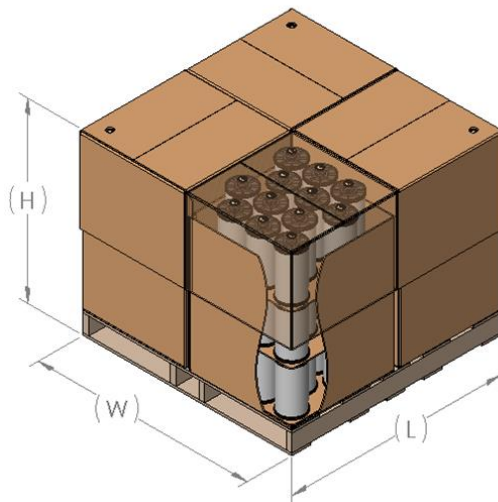

Storage, Shelf Life and Handling

Storage and Shelf Life:

AGY recommends storing the materials in accordance with appropriate safety considerations, away from exposure to the elements and at 65-80F (18-27C) and 50-70% humidity. If the materials are stored under these conditions, they are stable, non reactive and will not degrade or exhibit negative characteristics for at least 3 years from the date of manufacture. Unused, unopened product older than this is likely still in good condition, however careful evaluation is recommended. Prior to use, pallets should be placed in the production area and any plastic wrap removed for a minimum of 24 hours to allow the material to acclimate to the processing environment. Special care should be given to pallets being moved from a cold environment into a warm, humid area as condensation may occur and this additional moisture can negatively impact the runability of the material, however, once the material has acclimated, this will no longer be an issue.

For product traceability reasons, the pallet label should be recorded or retained.

Handling:

Fiberglass products process best if temperature and humidity are controlled, primarily because this will help to minimize the buildup of static electricity, fuzz and fly. AGY recommends that the material be run at 70 +/- 5 degrees F (18-27C) and 60 +/- 5% RH.

Test Methods and Certificates

A copy of test methods and or a certificate of conformity may be issued upon request.

Packages will be firmly and evenly wound on the bobbin, and free from defects in workmanship. AGY accepts no responsibility for damaged material that shows any signs of physical abuse.

For additional product information, refer to PTS M-710

AGY – World Headquarters / Americas

2556 Wagener Road
 Aiken, South Carolina, USA 29801
 Phone: +(1) 888.434.0945 (toll free)
 +(1) 803.643.1501
 Fax: +(1) 803.643.1180
 Email: asktheexpert@agy.com

AGY – Europe

Le Gemellyon Nord
 57 Boulevard Marius Vivier Merle
 69003 Lyon, France
 Phone: +(33) 4727 81775
 Fax: +(33) 4727 81780

AGY – Asia

Suite 1306-8, Bldg. 1,
 No. 1628 Jinshajiang Rd.
 Shanghai 200333 China
 Phone: +(86) 21 3251 3871
 Fax: +(86) 21 3251 2839